

# Owner's Manual

Please read before using this unit.

## DVD/CD Player

# MDV3000/F7

# MAGNAVOX

INSTRUCCIONES EN  
ESPAÑOL INCLUIDAS.

### Supplied Accessories

- Remote Control (NB098UD/NB690UD)
- AA (1.5V) battery x2
- Audio / video cables
- SETUP MANUAL

### Connecting to RF Modulator (Not Supplied)

If your TV has antenna in jack only, it is still possible to connect this unit to your TV by using an RF modulator. In this case, follow the instructions below.

- 1) Disconnect the power cords of the devices from the AC outlet.
- 2) Make the connection as illustrated below.
- 3) Set your RF modulator's channel 3/4 switch to either 3 or 4, whichever the TV channel is least used in your area. If your RF modulator has a modulator / antenna switch, set it according to the manual supplied with the RF modulator.
- 4) Plug in the power cords of the devices to the AC outlet.
- 5) Turn on your TV and choose the same channel as you set the RF modulator's channel 3/4 switch to. For more details, follow the manual supplied with the RF modulator.

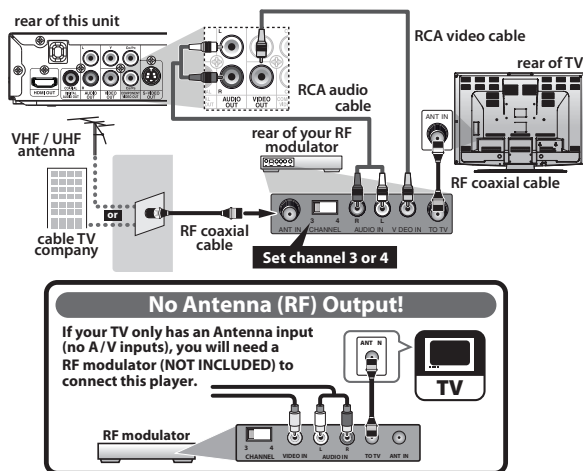

### Contents

#### PRECAUTIONS

<b>IMPORTANT SAFETY INSTRUCTIONS</b> .....	2
<b>About the Discs</b> .....	5
Playable Discs .....	5
Unplayable Discs .....	5

#### SETUP

<b>Connections</b> .....	6
Connection to a TV .....	6
HDMI Audio .....	7
HDMI Mode and Actual Output Signals .....	7
Connection to an Audio System .....	8
Rear Terminals .....	8
<b>About the Remote Control</b> .....	9
Remote Control .....	9
Installing the Batteries for the Remote Control .....	9

#### DVD FUNCTIONS

<b>Playback</b> .....	10
<b>MP3 / JPEG Playback</b> .....	11
<b>Search Functions</b> .....	11
Using Track / File / Folder Search .....	11
Using Title / Chapter Search .....	11
Using Time Search .....	11
<b>On-Screen Display</b> .....	12
<b>Repeat / Random / Programmed Playback</b> .....	13
Repeat Playback .....	13
Repeat A-B Playback .....	13
Random Playback .....	13
Programmed Playback .....	13
<b>Special Settings</b> .....	14
Subtitle Language .....	14
Audio Language .....	14
Camera Angles .....	14
Stereo Sound Mode .....	14
<b>DVD Setting</b> .....	15
Language Setting .....	15
Display Setting .....	16
Video Setting .....	16
Audio Setting .....	17
Others Setting .....	18

#### INFORMATION

<b>Troubleshooting Guide</b> .....	19
<b>Specifications</b> .....	19
<b>Español</b> .....	20
<b>LIMITED WARRANTY</b> .....	back cover

#### Note:

- RF modulator is not supplied with this unit. You need to purchase it at your local store.
- The quality of picture may become poor if this unit is connected to an RF modulator.

If you need additional operating assistance after reading this owner's manual, please call

**TOLL FREE : 1-800-605-8610**

or visit our web site at

[www.magnavox.com/support](http://www.magnavox.com/support)

# PRECAUTIONS

The model and serial numbers of this unit may be found on the cabinet.  
You should record and retain those numbers for future reference.

Model No.: \_\_\_\_\_

Serial No.: \_\_\_\_\_

**WARNING:** TO REDUCE THE RISK OF FIRE OR ELECTRIC SHOCK, DO NOT EXPOSE THIS APPARATUS TO RAIN OR MOISTURE. APPARATUS SHALL NOT BE EXPOSED TO DRIPPING OR SPLASHING AND NO OBJECTS FILLED WITH LIQUIDS, SUCH AS VASES, SHALL BE PLACED ON THE APPARATUS.



**CAUTION**  
**RISK OF ELECTRIC SHOCK**  
**DO NOT OPEN**



**CAUTION:**

TO REDUCE THE RISK OF ELECTRIC SHOCK, DO NOT REMOVE COVER (OR BACK). NO USER SERVICEABLE PARTS INSIDE. REFER SERVICING TO QUALIFIED SERVICE PERSONNEL.



The lightning flash with arrowhead symbol, within an equilateral triangle, is intended to alert the user to the presence of uninsulated 'dangerous voltage' within the product's enclosure that may be of sufficient magnitude to constitute a risk of electric shock to persons.



The exclamation point within an equilateral triangle is intended to alert the user to the presence of important operating and maintenance (servicing) instructions in the literature accompanying the appliance.

The important note is located on the rear or bottom of the cabinet.

 The symbol for CLASS II (Double Insulation)

## IMPORTANT SAFETY INSTRUCTIONS

1. Read these instructions.
2. Keep these instructions.
3. Heed all warnings.
4. Follow all instructions.
5. Do not use this apparatus near water.
6. Clean only with dry cloth.
7. Do not block any ventilation openings. Install in accordance with the manufacturer's instructions.
8. Do not install near any heat sources such as radiators, heat registers, stoves, or other apparatus (including amplifiers) that produce heat.
9. Do not defeat the safety purpose of the polarized or grounding-type plug. A polarized plug has two blades with one wider than the other. A grounding type plug has two blades and a third grounding prong. The wide blade or the third prong are provided for your safety. If the provided plug does not fit into your outlet, consult an electrician for replacement of the obsolete outlet.
10. Protect the power cord from being walked on or pinched particularly at plugs, convenience receptacles, and the point where they exit from the apparatus.
11. Only use attachments / accessories specified by the manufacturer.
12. Use only with the cart, stand, tripod, bracket, or table specified by the manufacturer, or sold with the apparatus. When a cart is used, use caution when moving the cart / apparatus combination to avoid injury from tip-over. 
13. Unplug this apparatus during lightning storms or when unused for long periods of time.
14. Refer all servicing to qualified service personnel. Servicing is required when the apparatus has been damaged in any way, such as power-supply cord or plug is damaged, liquid has been spilled or objects have fallen into the apparatus, the apparatus has been exposed to rain or moisture, does not operate normally, or has been dropped.

**FCC WARNING**

This equipment may generate or use radio frequency energy. Changes or modifications to this equipment may cause harmful interference unless the modifications are expressly approved in the manual. The user could lose the authority to operate this equipment if an unauthorized change or modification is made.

**RADIO-TV INTERFERENCE**

This equipment has been tested and found to comply with the limits for a Class B digital device, pursuant to Part 15 of the FCC Rules. These limits are designed to provide reasonable protection against harmful interference in a residential installation. This equipment generates, uses, and can radiate radio frequency energy and, if not installed and used in accordance with the instructions, may cause harmful interference to radio communications. However, there is no guarantee that interference will not occur in a particular installation. If this equipment does cause harmful interference to radio or television reception, which can be determined by turning the equipment off and on, the user is encouraged to try to correct the interference by one or more of the following measures:

- 1) Reorient or relocate the receiving antenna.
- 2) Increase the separation between the equipment and receiver.
- 3) Connect the equipment into an outlet on a circuit different from that to which the receiver is connected.
- 4) Consult the dealer or an experienced radio/TV technician for help.

**This Class B digital apparatus complies with Canadian ICES-003.**  
**Cet appareil numérique de la classe B est conforme à la norme NMB-003 du Canada.**

**Disconnect the mains plug to shut off when find trouble or not in use. The mains plug shall remain readily operable.**

**CAUTION:** Danger of explosion if battery is incorrectly replaced. Replace only with the same or equivalent type.  
**WARNING:** Batteries (Battery pack or battery installed) shall not be exposed to excessive heat such as sunshine, fire, or the like.

#### LASER SAFETY

This apparatus employs a laser. Only a qualified service person should remove the cover or attempt to service this apparatus, due to possible eye injury.

**CAUTION:** Use of controls or adjustments or performance of procedures other than those specified herein may result in hazardous radiation exposure.

**CAUTION:** Visible and invisible laser radiation when open and interlocks defeated. Do not stare into beam.

**LOCATION:** Inside, near the deck mechanism.

#### IMPORTANT COPYRIGHT INFORMATION

Unauthorized copying, broadcasting, public performance and lending of discs are prohibited. This product incorporates copyright protection technology that is protected by U.S. patents and other intellectual property rights. Use of this copyright protection technology must be authorized by Macrovision, and is intended for home and other limited viewing uses only unless otherwise authorized by Macrovision. Reverse engineering or disassembly is prohibited.

Do not place the unit on the furniture that is capable of being tilted by a child and an adult leaning, pulling, standing or climbing on it. A falling unit can cause serious injury or even death.

#### To Avoid the Hazards of Electrical Shock and Fire

- Do not handle the AC power cord with wet hands.
- Do not pull on the AC power cord when disconnecting it from an AC outlet. Grasp it by the plug.
- Do not put your fingers or objects into the unit.

#### Location and Handling

- Do not install the unit in direct sunlight, near strong magnetic fields, or in a place subject to dust or strong vibration.
- Avoid a place with drastic temperature changes.
- Install the unit in a horizontal and stable position. Do not place anything directly on top or bottom of the unit. Depending on your external devices, noise or disturbance of the picture and/or sound may be generated if the unit is placed too close to them. In this case, please ensure enough space between the external devices and the unit.
- Depending on the environment, the temperature of this unit may increase slightly. This is not a malfunction.
- Be sure to remove the disc and unplug the AC power cord from the outlet before carrying the unit.

#### Dew Condensation Warning

- Dew condensation may form inside the unit in the following conditions. If so, do not use this unit at least for a few hours until its inside gets dry.
  - The unit is moved from a cold place to a warm place.
  - Under conditions of high humidity.
  - After heating a cold room.

#### Note about Recycling

- This unit's packaging materials are recyclable and can be reused. Please dispose of any materials in accordance with your local recycling regulations.
- Batteries should never be thrown away or incinerated but disposed of in accordance with your local regulations concerning chemical wastes.
- For product recycling information, please visit - [www.magnavox.com](http://www.magnavox.com)





#### Notice for Progressive Scan Output

- Consumers should note that not all high definition television sets are fully compatible with this product and may cause artifacts to be displayed in the picture. In case of picture problems with 525(480) progressive scan output, it is recommended that the user switch the connection to the 'standard definition' output. If there are questions regarding your TV set compatibility with this 525p(480p) DVD player, please contact our customer service center.

**TRADEMARK INFORMATION**

 HDMI, the HDMI logo and High-Definition Multimedia Interface are trademarks or registered trademarks of HDMI Licensing LLC.





 Manufactured under license from Dolby Laboratories. Dolby and the double-D symbol are trademarks of Dolby Laboratories.

 Products that have earned ENERGY STAR® are designed to protect the environment through superior energy efficiency.

 is a trademark of DVD Format / Logo Licensing Corporation.

**SYMBOLS USED IN THIS MANUAL**

The following symbols appear in some headings in this manual.

-  : Description refers to DVD-video.
-  : Description refers to audio CD.
-  : Description refers to DVD, CD-RW/-R with MP3 files.
-  : Description refers to DVD, CD-RW/-R with JPEG files.

**MAINTENANCE**

**Serviceing**

- Please refer to relevant topics on the “Troubleshooting Guide” on page 19 before returning the unit.
- If this unit becomes inoperative, do not try to correct the problem by yourself. There are no user-serviceable parts inside. Turn off, unplug the power plug, and please call our help line mentioned on the front page to locate an authorized service center.

**Cleaning the Cabinet**

- Wipe the front panel and other exterior surfaces of the unit with a soft cloth.
- Never use a solvent, thinner, benzene or alcohol to clean the unit. Do not spray insecticide liquid near the unit. Such chemicals may discolor the surface or damage the unit.

**Cleaning Discs**

- When a disc becomes dirty, clean it with a cleaning cloth. Wipe the disc from the center to out. Do not wipe in a circular motion.
- Do not use solvents such as benzene, thinner, commercially available cleaners, detergent, abrasive cleaning agents or antistatic spray intended for analog records.

**Cleaning the Disc Lens**

- If this unit still does not perform properly although you refer to the relevant sections and to “Troubleshooting Guide” in this owner’s manual, the laser optical pickup unit may be dirty. Consult your dealer or an authorized service center for inspection and cleaning of the laser optical pickup unit.

**Disc Handling**

- When you handle a disc, hold it by its edge and try not to touch the surface of the disc.
- Always store the disc in its protective case when not in use.

MAGNAVOX is a registered trademark of Philips Electronics North America Corporation and is used by Funai Electric Co. Ltd. and Funai Corporation, Inc. under license from Philips Electronics North America.

© 2011 Funai Electric Co., Ltd.

All rights reserved. No part of this manual may be reproduced, copied, transmitted, disseminated, transcribed, downloaded or stored in any storage medium, in any form or for any purpose without the express prior written consent of Funai. Furthermore, any unauthorized commercial distribution of this manual or any revision hereto is strictly prohibited.

Information in this document is subject to change without notice. Funai reserves the right to change the content herein without the obligation to notify any person or organization of such changes.

# About the Discs

## Playable Discs

Type of media	Mark (logo)	Region code	Recorded signals	Disc size	Disc types
DVD-video *1, 2, 4, 6, 8		or	digital video (MPEG2)	5 inches (12 cm) or 3 inches (8 cm)	<b>DVD-Video</b> e.g.) 
DVD+RW DVD+R *1, 4, 5, 6, 7, 8		—	digital video (MPEG2) or MP3/JPEG		<b>DVD</b> e.g.)  <b>MP3/JPEG</b> e.g.) 
audio CD *4, 6, 8		—	digital audio		<b>audio CD</b> e.g.)  <b>MP3/JPEG</b> e.g.) 
CD-RW CD-R *4, 5, 6, 7, 8		—	digital audio or MP3/JPEG	5 inches (12 cm) or 3 inches (8 cm)	<b>audio CD</b> e.g.)  <b>MP3/JPEG</b> e.g.) 
Kodak Picture CD *4, 5, 6, 7, 8		—	JPEG		

is a trademark of DVD Format / Logo Licensing Corporation.

is trademark of Eastman Kodak Company.

### If you cannot play back a disc which bears one of the marks above, check the following notes.

- \*1: This unit conforms to the NTSC color system. Discs recorded in other color systems such as PAL cannot be played back.
- \*2: Certain DVD-video do not operate as described in this manual due to the intentions of the disc's producers.
- \*3: Discs recorded in the VR (Video Recording) format cannot be played back.
- \*4: Scratched or stained discs may not be played back.
- \*5: Some discs cannot be played back because of incompatible recording conditions, characteristics of the recorder or special properties of discs.
- \*6: You can play back discs which bear the marks above. If you use non-standardized discs, this unit may not play them back. Even if they are played back, the sound or video quality will be compromised.
- \*7: If the recorded portion of the disc is too small (smaller than 2-3/16 inches (55mm) across), it may not be played back.
- \*8: Do not glue paper or put stickers on to the disc. These may damage the disc, and the unit may not read it correctly.

## Unplayable Discs

### NEVER play back the following discs as malfunction may result!

DVD-RAM / DVD-audio / CD-i / photo CD / DVD with region codes other than 1 or ALL / DTS-CD / DVD-ROM for personal computers / CD-ROM for personal computers / HD DVD / Blu-ray Disc™

### On the following disc, the sound MAY NOT be heard.

super audio CD

### Any other discs without compatibility indications

### Note:

- Only the sound recorded on the normal CD layer can be delivered. The sound recorded on the high density super audio CD layer cannot be delivered.

# SETUP

## Connections

### Connection to a TV

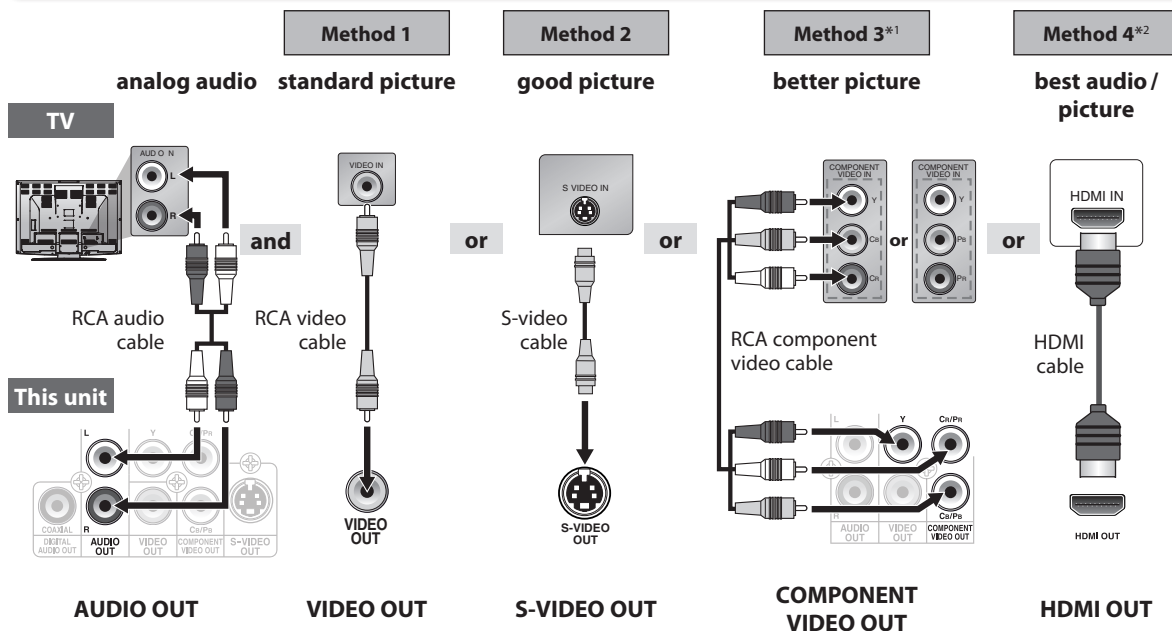

\*1 This unit is compatible with the progressive scan system. The feature provides you with the higher quality pictures than traditional output system does. To utilize this feature, a component connection is required. Refer to "Resolution" setting on page 18 or "Progressive" setting on page 16 to set the video resolution.

\*2 Analog audio connection is not required for this connection.

#### Supplied cables used in this connection are as follows:

- RCA audio cable (L/R) x 1
- RCA video cable x 1

Please purchase the rest of the necessary cables at your local store.

#### Note:

- Connect this unit directly to your TV. If RCA audio/video cables are connected to a VCR, pictures may be distorted due to the copy protection system.
- Changing "Progressive" setting is not available while HDMI cable is connected.

#### If your TV is compatible with 525 (480) progressive scanning and you want to enjoy that high quality picture;

You must select the connection COMPONENT VIDEO OUT above and progressive scanning mode. To set the mode, set "Progressive" to "On" in "Video" menu. Refer to pages 15-16 for more details.

- When "Progressive" is "On", video signals from the unit's VIDEO OUT and S-VIDEO OUT jacks will be distorted or not be output at all.

#### If your TV is not compatible with progressive scanning;

Use this unit in interlace mode and set "Progressive" to "Off" in "Video" menu or by pressing and holding [PLAY ►] on the front of the unit for more than 5 seconds.

#### After connecting to your TV:

You will need to switch to video input on your TV. This is usually marked TV/VIDEO, INPUT or AUX. Please refer to your TV's owner's manual for details.

#### Input modes for common TV brands:

Listed below are inputs for common brand name TV's.

Admiral:	AUX	Panasonic:	TV/VIDEO
Curtis Mathis:	LINE1, LINE2, 00, 90, 91, 92, 93	RCA:	INPUT, TV/VCR, 00, 90, 91, 92, 93
GE:	INPUT, TV/VCR, 00, 90, 91, 92, 93	Samsung:	TV/VIDEO
Hitachi:	INPUT, AUX	Sanyo:	VIDEO
JVC:	VIDEO, VIDEO1, VIDEO2, VIDEO3	Sharp:	00
Kenwood:	AUX	Sony:	VIDEO1, VIDEO2, VIDEO3
LXI-Series:	00	Toshiba:	TV/GAME
Magnavox:	AUX CHANNEL	Zenith:	00

## HDMI Audio

Media	Audio Recording Format	HDMI Audio Setting	
		Bistream	LPCM
DVD-Video	Dolby Digital	Dolby Digital	Multi PCM
	LPCM	Multi PCM	Multi PCM
audio CD		2ch PCM	2ch PCM
MP3		2ch PCM	2ch PCM

## HDMI Mode and Actual Output Signals

Press **[HDMI]** to change the resolution of the video signal being output from the HDMI OUT. The video resolution changes as follows every time **[HDMI]** is pressed. Or change the setting in the "Resolution" in the settings menu.



e.g.) when 480p is selected as a default.

### Copyright protection system

To play back the digital video images of DVD-video via an HDMI connection, it is necessary that both the player and the display device (or an AV receiver / amplifier) support a copyright protection system called HDCP (high-bandwidth digital content protection system). HDCP is copy protection technology that comprises data encryption and authentication of the connected AV device. This unit supports HDCP. Please read the operating instructions of your display device (or AV receiver / amplifier) for more information.

### Note:

- When using HDCP-incompatible display device, the picture will not be viewed properly.
- The audio signals from the HDMI jack (including the sampling frequency, the number of channels and bit length) may be limited by the device that is connected.
- Among the display device(s) that support HDMI, some do not support audio output (for example, projectors). In connections with device such as this unit, audio signals are not output from the HDMI output jack.
- When this unit's HDMI jack is connected to a DVI-D compatible display device(s) (HDCP compatible) with an HDMIDVI converter cable, the signals are output in digital RGB.
- Pressing **[HDMI]** does not work when HDMI cable is not connected, or when no video signal is being output from the HDMI OUT jack.
- Pressing **[HDMI]** does not work when a DVI compatible display devices is connected. Change the video resolution in the "Resolution" in the settings menu.
- When you make a selection, the TV monitor temporarily goes blank and then comes back again. If it does not, press **[HDMI]** repeatedly to change the resolution or press and hold **[PLAY ►]** on the front panel for 5 seconds to change the setting back to its default.

## Connection to an Audio System

### Analog Audio Connection

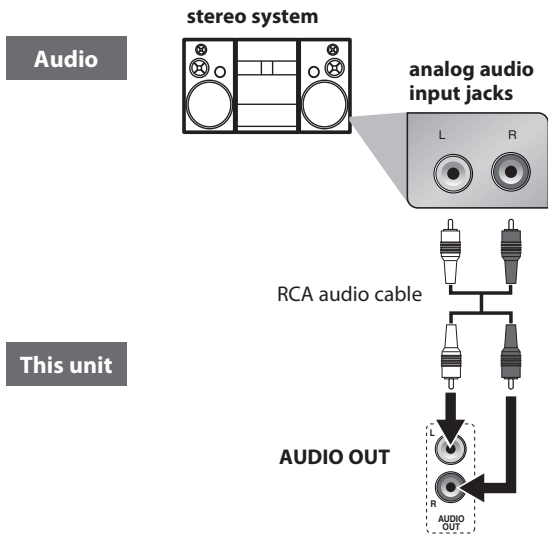

### Digital Audio Connection

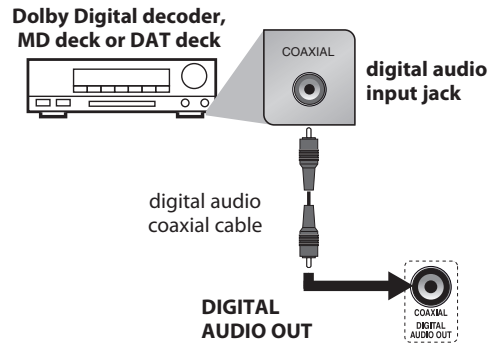

Connection	Setting	Setup > Audio > Digital Out
	Connecting to a Dolby Digital decoder for Dolby Digital audio output.	
Connecting to the other device (an MD deck or DAT deck etc.) without Dolby Digital decoder.		<b>LPCM</b>

\* To complete these settings, refer to pages 15,17.

#### Note:

- The audio source on a disc in a Dolby Digital multi-channel surround format cannot be recorded as digital sound by an MD or DAT deck.
- By hooking this unit up to a Dolby Digital decoder, you can enjoy high-quality Dolby Digital multi-channel surround sound as heard in the movie theaters.
- Playing back a DVD using incorrect settings may generate noise distortion and may also damage the speakers.
- "Digital Out" setting is not available while HDMI audio is output.

#### Supplied cables used in this connection are as follows:

- RCA audio cable (L/R) x 1
- Please purchase the rest of the necessary cables at your local store.

## Rear Terminals

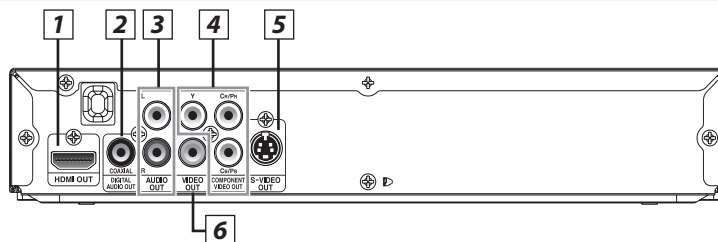

- HDMI OUT jack**  
Use to connect a TV with an HDMI compatible port with an HDMI cable.
- DIGITAL AUDIO OUT COAXIAL jack**  
Connect a digital audio coaxial cable here through the digital audio coaxial input jack of a decoder or audio receiver.
- AUDIO OUT jacks**  
Connect an audio cable here through the audio input jacks of a television or other audio device.
- COMPONENT VIDEO OUT jacks**  
Connect a component video cable here through the component video input jacks of a television.
- S-VIDEO OUT jack**  
Connect an S-video cable here through the S-video input jack of a television.
- VIDEO OUT jack**  
Connect a video cable here through the video input jack of a television.



# About the Remote Control

## Remote Control

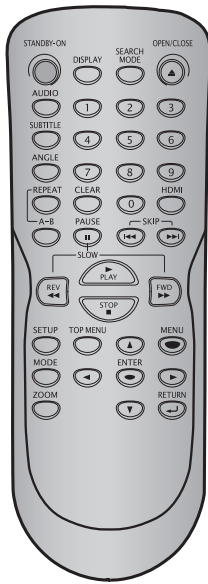

## Installing the Batteries for the Remote Control

Install 2 AA (1.5V) batteries matching the polarity indicated inside battery compartment of the remote control.



Keep in mind the following when using the remote control:

- Make sure that there are no obstacles between the remote control and the remote sensor on the unit.
- The maximum operable ranges from the unit are as follows.

**- Line of sight:**

approx. 23 feet (7m)

**- Either side of the center:**

approx. 16 feet (5m) within 30°

**- Above:** approx. 16 feet (5m) within 15°

**- Below:** approx. 10 feet (3m) within 30°



**Note:**

- Do not mix alkaline, standard (carbon-zinc), or rechargeable (ni-cad, ni-mh, etc) batteries.
- Do not mix old and new batteries.
- Always remove batteries from remote control if they are dead or if the remote control is not to be used for an extended period of time. This will prevent battery acid from leaking into the battery compartment.

Button (Alphabetical order)	Media	DVD	CD	MP3	JPEG
1-9, 0		• To enter values in the input field. • To select chapter or title directly.	• To enter values in the input field. • To select track directly. (CD) • To select folder / file directly. (MP3 / JPEG)		
Left, Right, Up, Down		• To move the cursor and determine its position.	• To move the cursor and determine its position. • To rotate the JPEG.		
A-B		• To repeat between your chosen point of A and B.	• To repeat between your chosen point of A and B. (CD / MP3)		
ANGLE		• To select camera angles on a disc.	—		
AUDIO		• To select audio language on a disc.	• To select "Stereo", "L-ch" or "R-ch". (CD)		
CLEAR		• To cancel the point for A-B repeat. • To clear the numbers entered incorrectly.	• To cancel the point for A-B repeat. (CD / MP3) • To remove status number in program input. • To clear the numbers entered incorrectly.		
DISPLAY		• To display the current disc mode.	• To display the current disc mode.		
ENTER		• To select items or settings.	• To select items or settings.		
HDMI		• To set the HDMI output mode.	• To set the HDMI output mode.		
REV, FWD		• To search forward / backward through a disc. (x2, x4, x8, x16, x32) • To begin slow forward/backward playback in the pause mode.	• To search forward/backward through a disc. (x2, x4, x8, x16, x32)		
MENU		• To call up the menu on a disc.	—		
MODE		—	• To arrange the playing order or play randomly.		
OPEN/CLOSE		• To open or close the disc tray. • To turn on the unit.	• To open or close the disc tray. • To turn on the unit.		
PAUSE		• To pause disc playback. • To advance playback one frame at a time.	• To pause disc playback.		
PLAY		• To start playback or resume playback.	• To start playback or resume playback.		
REPEAT		• To play back a chapter or title repeatedly.	• To play back a track or disc repeatedly. (CD) • To play back a file, folder or disc repeatedly. (MP3 / JPEG)		
RETURN		• To return to the previously displayed menu screen.	• To return to the previously displayed menu screen. • When file list is shown, press to switch folder list. (MP3 / JPEG)		
SEARCH MODE		• To search chapter, title or time.	• To search tracks or files. • To search time. (CD / MP3) • To search folders. (MP3 / JPEG)		
SETUP		• To call up the setup menu.	• To call up the setup menu.		
SKIP		• To skip chapters or titles.	• To skip tracks or files. • When file list / folder list is shown, press to switch between pages. (MP3 / JPEG)		
STANDBY-ON		• To turn the unit on or to turn the unit into the standby mode. (To completely turn off the unit, you must unplug the AC power cord.)	• To turn the unit on or to turn the unit into the standby mode. (To completely turn off the unit, you must unplug the AC power cord.)		
STOP		• To stop playback.	• To stop playback.		
SUBTITLE		• To select subtitle language on a disc.	—		
TOP MENU		• To call up the title menu on a disc.	—		
ZOOM		• To magnify part of a picture. (x2, x3, x4, x1/2, x1/3, x1/4)	• To magnify part of a picture. (JPEG) (x2, x3, x4, x1/2, x1/3, x1/4)		

# DVD FUNCTIONS

Please note : most instructions in this manual refer to remote control use.

## Playback

Before:

Turn on the TV, amplifier and any other device which are connected to this unit. Make sure the TV and audio receiver (not supplied) are set to the correct channel.

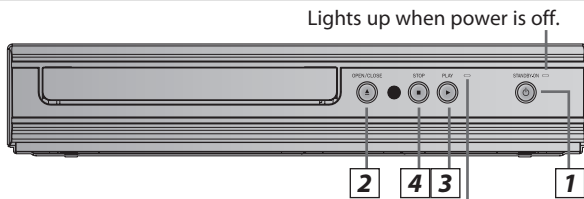
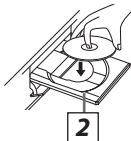

- 1 Press **[STANDBY-ON]** to turn on this unit.
- 2 Press **[OPEN / CLOSE ▲]** and insert a disc with label facing up.
- 3 Press **[PLAY ►]** to start playback.
- 4 Press **[STOP ■]** to stop playback.

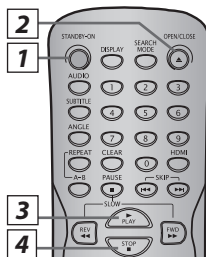

Lights up when discs playback.

### Note:

- When you play back a DVD or CD-RW/-R with MP3 / JPEG files, details on page 11.
- A "⊘" may appear at the top-right on the TV screen when the operation is prohibited by the disc or this unit.
- Some DVD may start playback from title 2 or 3 due to specific programs.
- During the playback of a 2-layered disc, pictures may stop for a moment. This happens while the 1st layer is being switched to the 2nd layer. This is not a malfunction.
- You can change the on-screen language in "Player Menu" setting. (Refer to page 15.)

### Disc Menu



Some discs contain menus which allow you to customize DVD playback. Use **[▲ / ▼ / ◀ / ▶]** to select an item, then press **[ENTER]** or **[PLAY ►]**.

### Calling Up a Menu Screen during Playback



- Press **[MENU]** to call up the disc menu.
- Press **[TOP MENU]** to call up the title menu.

### Note:

- Menu operations may vary depending on the disc. Refer to the manual accompanying the disc for more details.

### Resume Playback



Press **[STOP ■]** during playback. Resume icon will appear at the top-left on the TV screen. Press **[PLAY ►]**, playback will resume from the point at which playback was stopped.



### Note:

- To cancel resume, press **[STOP ■]** one more time in the stop mode.
- The resume playback information stays on even when the power is turned off, as long as the disc stays in the unit.

### Paused and Step-by-Step Playback



Press **[PAUSE ■]** during playback. To continue playback, press **[PLAY ►]**.



The disc goes forward by one frame each time **[PAUSE ■]** is pressed in the pause mode. To continue playback, press **[PLAY ►]**.

### Fast Forward / Reverse Search



Use **[FWD ►►]** or **[REV ◀◀]** repeatedly during playback to select the required forward or reverse speed. To continue playback, press **[PLAY ►]**.



### Note:

- Fast forward or reverse search speed is different depending on the disc. Approximate speed is x2, x4, x8, x16 and x32.

### Slow Forward / Reverse Search



Press **[FWD ►►]** or **[REV ◀◀]** repeatedly in the pause mode to select the required forward / reverse speed. To continue playback, press **[PLAY ►]**.



### Note:

- Slow forward / reverse speed is different depending on the disc. Approximate speed is x1/32, x1/16, x1/8, x1/4 and x1/2.

### Zoom



- 1) Press **[ZOOM]** repeatedly during playback to select the required zoom factor: x2, x3, x4, x1/2, x1/3, x1/4 or off.
- 2) Use **[▲ / ▼ / ◀ / ▶]** to slide the zoomed picture across the TV screen.
- 3) To exit zoom function, press **[ZOOM]** repeatedly to select off.



### Note:

- Zooming function does not work while the disc menu is displayed.
- Some part of the picture may not be zoomed depending on the disc or playback status.

# MP3 / JPEG Playback

MP3 / JPEG is a method of compressing files. You can copy MP3 / JPEG files on DVD or CD-RW/-R from the computer and play back the files on this unit.



Insert an MP3 / JPEG format disc, then the file list will automatically appear on the TV screen. For a disc with MP3 or JPEG files only, all repeat playback will start automatically.

**1** Select the desired folder or file.

e.g.) JPEG

**2** Press [ENTER] or [PLAY ▶]. Playback will start from the first file of the folder or files.

**Note:**

- Some selections may take a while to be recognized.
- Refer to "On-Screen Display" on page 12 for more details.
- If you record data over 20 times, it may not be played back correctly.
- For a disc with JPEG files only, the file list will appear while in stop mode.
- A maximum of 498 folders or 4000 files may be recognized on one disc.
- Up to 8 hierarchies can be recognized in one folder. File in the 9th or deeper hierarchies cannot be played back.
- To rotate the picture, press cursors during playback JPEG files.

This unit recommends the files recorded under the following circumstances:

Applicable MP3 file	Remarks
Sampling frequency: 44.1 kHz or 48 kHz	For MP3 file recorded in VBR (variable bit rate), the unit may not display the actual elapsed time.
Constant bit rate: 32 kbps ~ 320 kbps	

Applicable JPEG file	Remarks
<b>Normal playback</b> Upper limit: 6,300 x 5,100 Pixel lower limit: 32 x 32 pixel File size: Max. 7 MB	A JPEG image that extends beyond the screen is reduced so that it will be displayed within the screen.

# Search Functions

## Using Track / File / Folder Search



### Using [SEARCH MODE]

**1** SEARCH MODE

e.g.) CD

**2** Enter the desired track / file / folder number within 10 seconds.

**3** Press [ENTER].

- To play back the tracks, files or folders whose track / file / folder number is double-digit or larger, press the number directly.  
e.g.)  
- for file 14, press [1], [4] and [ENTER].  
- for file 114, press [1], [1], [4] and [ENTER].  
- for file 1114, press [1], [1], [1] and [4].

### Using [SKIP ◀◀, ▶▶]

**1**

e.g.) Track

**Note:**

- For audio CDs, MP3 and JPEG files, track / file / folder search are not available for programmed or random playback.

Available Search Mode	Displayed list
Track Search	No list displayed 
File Search	File list 
Folder Search	Folder list 

## Using Title / Chapter Search



### Using [SEARCH MODE]

**1** SEARCH MODE

e.g.) DVD

Press [SEARCH MODE] once for the title search.  
For the chapter search, press cursor [▶] to highlight [CH].

**2** Enter the desired title or chapter number within 10 seconds.

**3** Press [ENTER].

### Using [SKIP ◀◀, ▶▶]

**1**

**Note:**

- Depending on the disc being played back, this function can also be performed by directly entering the desired chapter number with [the Number buttons]. Refer to the manual accompanying the disc.

## Using Time Search



**1** SEARCH MODE

e.g.) DVD

Press cursor [▶] to highlight [CH].  
CD / MP3: once  
DVD: twice

**2** Enter the desired time within 10 seconds.

**3** Press [ENTER].

**Note:**

- To play time 00:15:00, press [1], [5], [10], [0] of [the Number buttons].
- Press [CLEAR] to erase the incorrect input at step 2.
- For audio CD and MP3, time search is not available for programmed or random playback.

DVD FUNCTIONS

# On-Screen Display



You can check the information about the current disc by pressing [DISPLAY].

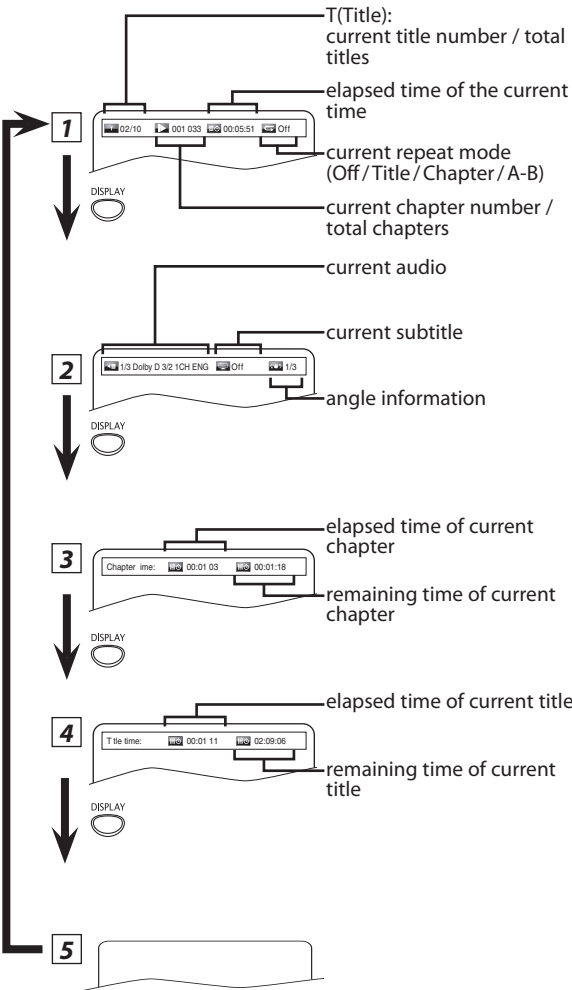

**Note:**  
• Some DVD will not allow you to set chapter playback correctly.



You can check the information about the current disc by pressing [DISPLAY].

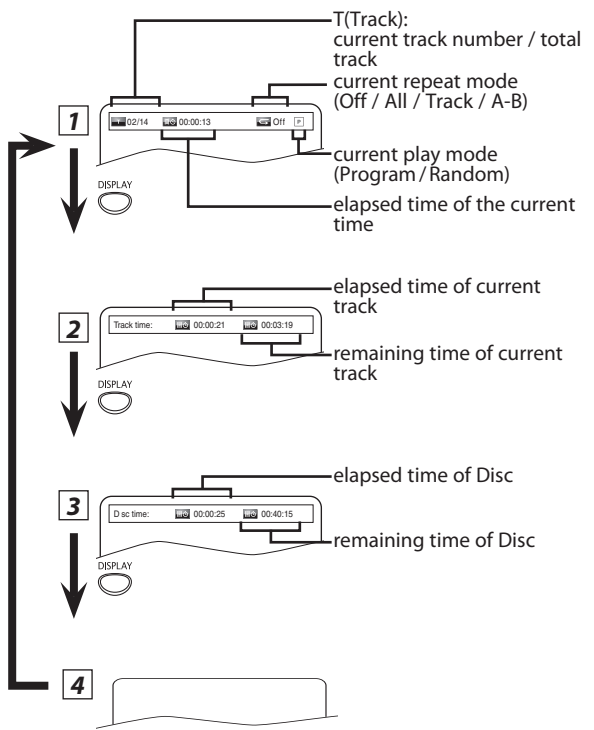

• Only in stop mode for JPEG.

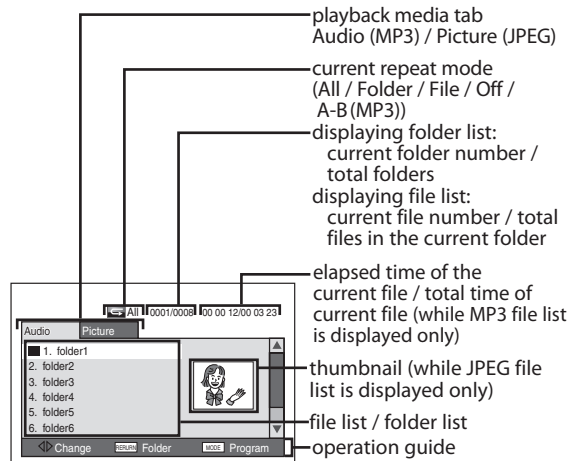

DVD FUNCTIONS

# Repeat / Random / Programmed Playback

## Repeat Playback



Repeat function is available only during playback.

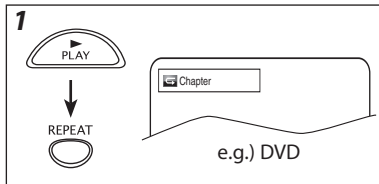

Each time you press **[REPEAT]**, repeat function changes as example below.

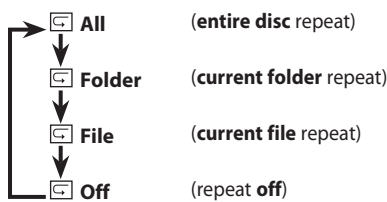
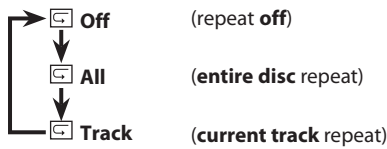
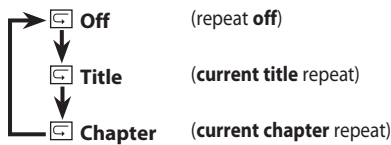

### Note:

- Repeat setting (except "All") will be cleared when moving to another title, chapter, track, file or folder (only for DVD and CD).
- To clear the repeat setting for MP3 and JPEG files, set the repeat setting to "Off".
- This function is not available with some discs or during repeat A-B playback.

## Repeat A-B Playback



Repeat function is available only during playback and set the repeat setting to "Off".

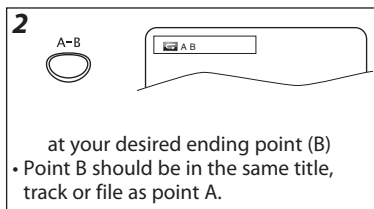
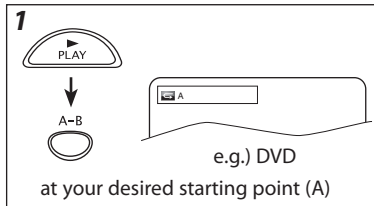

### Note:

- To exit the sequence, press **[A-B]** so that "Off" appears.
- To cancel point A, press **[CLEAR]** at step 1.
- This function does not work in the other repeat modes.

## Random Playback



This function shuffles the playing order of files or tracks instead of playback in the sequence.

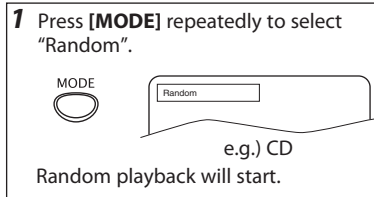

### Note:

- During random playback, you cannot go back to the previous track or file, using **[SKIP ►►]** allows you to search tracks or files randomly.

## Programmed Playback



You may determine the order in which tracks or files will play back.

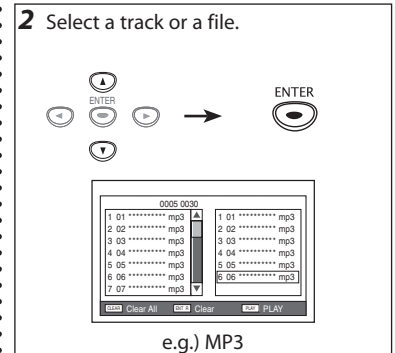
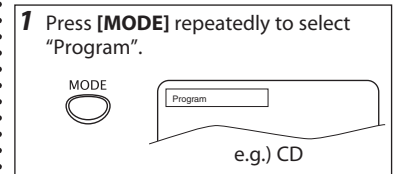

- Up to 20 files or tracks can be ordered.

### When the highlight is in the track / file list

- [RETURN]**: exit from the program menu.
- [ENTER]**: select a track / file.
- [PLAY ►]**: start program playback.

### When the highlight is in the programmed list

- [CLEAR]**: erase all the track / file in the program.
- [ENTER]**: erase the track / file you select.
- [PLAY ►]**: start program playback.

### Note:

- While a program is being played back, **[STOP ■]** works as follows;
  - Press **[STOP ■]** and **[PLAY ►]** next, so that the programmed playback restarts.
  - Press **[STOP ■]** twice and **[PLAY ►]** next, so that playback restarts from the first track in the original order.
- However, your programmed playback can be restarted when you follow the above steps. (Your programs are still stored until either the disc is removed or power is turned off.)

# Special Settings

## Subtitle Language



This unit allows you to select a subtitle language (if available) during DVD playback.

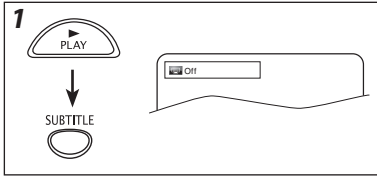

Each time you press [SUBTITLE], subtitle language changes as example below.

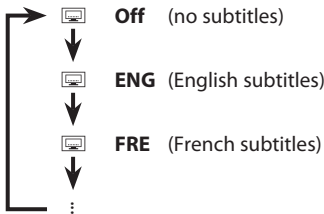

## Audio Language



This unit allows you to select an audio language (if multiple languages are available on disc) during DVD playback.

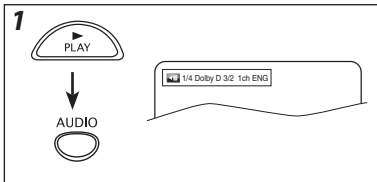

Each time you press [AUDIO], audio language changes as example below.

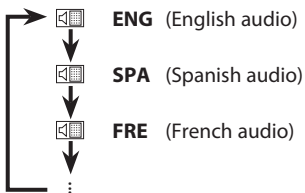



### Note:

- Some discs will only allow you to change the audio setting from the disc menu. Refer to the manual accompanying the discs for details.
- If your language is not shown after pressing [AUDIO] several times, the disc may not have that language. However, some discs allow audio language setting on the disc menu. (Operation varies depending on the disc, so refer to the manual along with the disc.)

## Camera Angles



Some DVD may contain scenes which have been shot simultaneously from various angles. You can change the camera angle if  appears on the TV screen. If the "Angle Icon" setting is "Off" in "Display" menu,  will not appear. (Refer to pages 15-16.)

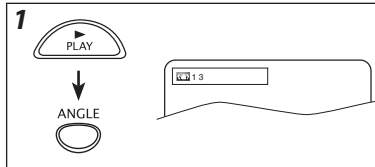

Each time you press [ANGLE], camera angle changes.

## Stereo Sound Mode



This unit allows you to select a sound mode during CD playback.

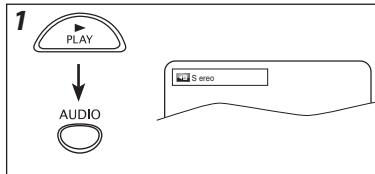

Each time you press [AUDIO], sound mode changes as example below.

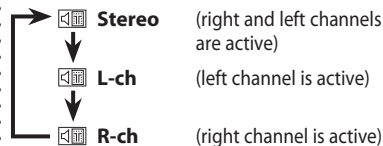

# DVD Setting

You can change the settings of the unit. You cannot change the setting during playback. Setting items are displayed in gray when they are not available under the conditions at the time.

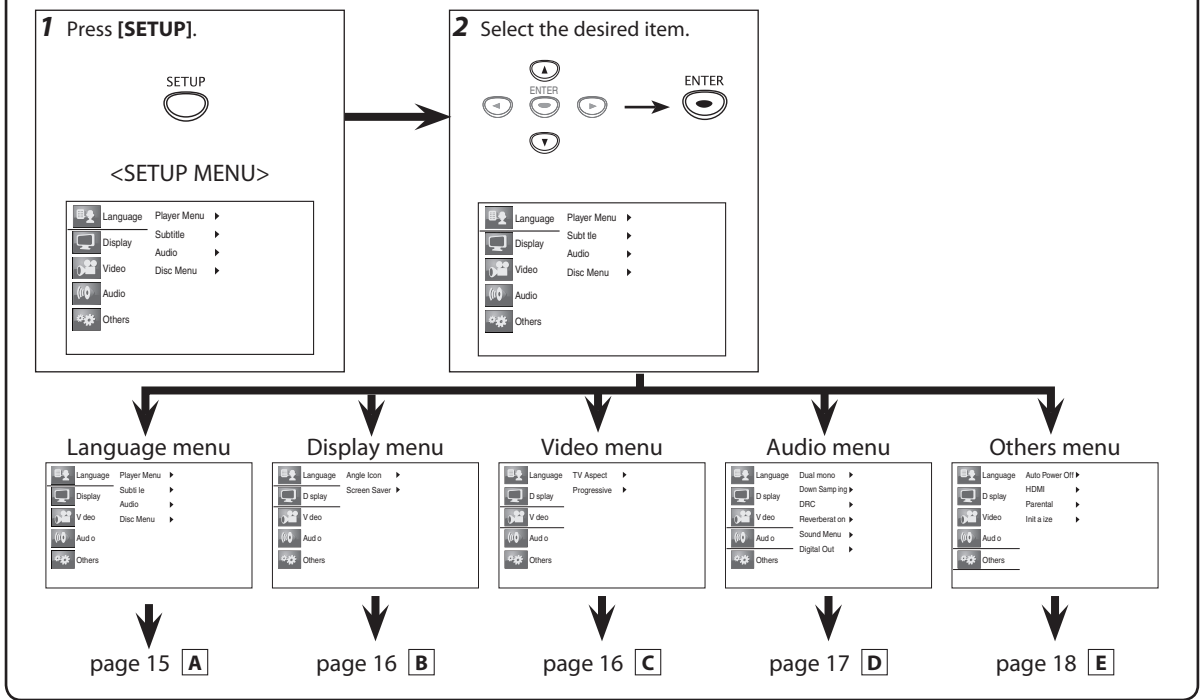

## A Language Setting

Follow steps 1 to 2 above.

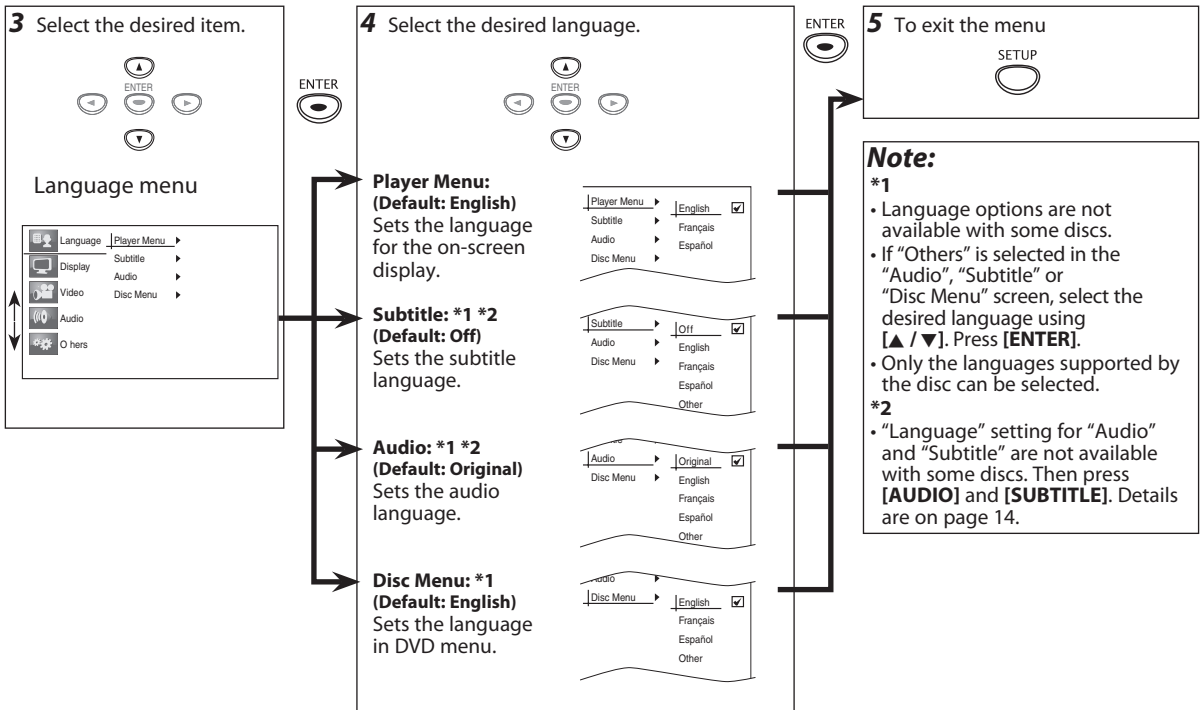

DVD FUNCTIONS



## B Display Setting

You can change the display functions. Follow steps 1 to 2 on page 15.

**3** Select the desired item.

**4** **Angle Icon: (Default: On)**  
See note on the right.

**Screen Saver: (Default: On)**  
See note on the right.

**5** To exit the menu

**Note:**

**Angle Icon:**

- Set to "On" to display when multiple camera angles are available during DVD playback.

**Screen Saver:**

- Sets whether to activate the screen saver after 5 minutes of no action on the unit.

## C Video Setting

You can change the video functions. Follow steps 1 to 2 on page 15.

**3** Select the desired item.

**4** **TV Aspect: (Default: 16:9 Wide)**  
Sets the aspect ratio of the playback image to fit your TV.

**Progressive: (Default: Off)**  
Changing "Progressive" setting is not available while HDMI cable is connected.

If there is no picture or you do not press any buttons for 15 seconds, "Progressive" will switch to "Off" and it will exit the setup menu.

**5** To exit "TV Aspect" menu

To complete "Progressive" setting

**Note:**

**TV Aspect:**

- Select "16:9 Wide" if a wide-screen TV is connected to this unit.
- Select "4:3 Letter Box", so that black bars may appear on the top and bottom of the TV screen.
- Select "4:3 Pan & Scan" for a full height picture with both sides adjusted.

**Progressive:**

- You can set "Progressive" to "Off" in "Video" menu or press and hold **[PLAY ▶]** on the front of the unit for more than 5 seconds during playback.
- When "Progressive" is "On", video signals from the unit's VIDEO OUT and S-VIDEO OUT jacks will be distorted or not be output at all.



## D Audio Setting

Choose the appropriate audio settings for your device. It only affects during the playback of DVD. Follow steps 1 to 2 on page 15.

**3** Select the desired item.

Audio menu

- Language Dual mono ▶
- Display Down Sampling ▶
- DRC
- Video Reverberation ▶
- Sound Menu ▶
- Audio Digital Out ▶
- Others

**Note:**

**Down Sampling:**

- When playing back disc with copyright protection, the sound will be down sampled at 48kHz, even if you set to "Off".

**DRC:**

- This function is available only on the discs which are recorded in the Dolby Digital format.
- "On" "7/8-1/8" "Off": Compress the range between soft and loud sounds.

**Digital Out:**

- When HDMI cable is connected, make sure "HDMI Audio" setting is set to "Off" to change the "Digital Out" setting.

**4**

**Dual mono: (Default: Stereo)**  
This unit allows you to select a sound mode during CD playback.

Select the desired setting.

---

**Down Sampling: (Default: On)**  
Set to "On" when outputting in 48kHz.  
Set to "Off" when outputting the original sound.

Select the desired setting.

---

**DRC (Dynamic Range Control): (Default: On)**  
Set to "On" to compress the range between soft and loud sounds.

Select the desired setting.

---

**Reverberation: (Default: Normal)**  
You can set the reverberation effect.

Select the desired setting.

---

**Sound Menu: (Default: Off)**  
You can enjoy stereophonic virtual world your existing 2 channel stereo system.

Select the desired setting.

---

**Digital Out: (Default: Bitstream)**  
Set to "Bitstream" when the unit is connected to a Dolby Digital decoder.

- Bitstream: outputs a Dolby Digital signals.
- LPCM: convert the Dolby Digital into LPCM (2 channel).

Select the desired setting.

**5** To exit the menu

**Note:**

**Reverberation:**

Normal:  
no effects  
(original sound)

Living Room:  
sounds as if you are in a living room

Hall:  
sounds as if you are in a hall

Arena:  
sounds as if you are in an arena

Cave:  
sounds as if you are in a cave

Concert Hall:  
sounds as if you are in a concert hall

Bath Room:  
sounds as if you are in a bath room

Cathedral:  
sounds as if you are in a cathedral

**Sound Menu:**

Off: no effects (original sound)

3D: sound mode suitable for setting stereophonic audio

Jazz: sound mode suitable for jazz music

Rock: sound mode suitable for rock music

Pop: sound mode suitable for pop music

Classic:  
sound mode suitable for classic music

- Sound Menu is available under the following condition:
  - When the unit is connected to a TV using AUDIO OUT jacks.
  - When "HDMI Audio" is set to "LPCM".
  - When "Digital Out" is set to "LPCM".

## E Others Setting

Follow steps 1 to 2 on page 15.

### 3 Select the desired item.

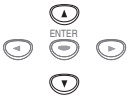

#### Others menu

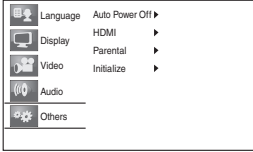

#### Note:

##### HDMI:

- You cannot select the video resolutions which are not supported by the connected TV, except when this unit's HDMI OUT jack is connected to a DVI compatible display devices with an HDMI-DVI cable (default is 480p in such case).
- Video and audio signals may be distorted temporarily when switching to / from the HDMI output mode.

##### Resolution:

- Auto:** HDMI video resolution will be selected automatically depending on the connected HDMI device. If you want to change the resolution manually, press [HDMI] repeatedly.
- When you make a selection, the TV monitor temporarily goes blank and then comes back again. If it does not, press [HDMI] to change the resolution or press and hold [PLAY] on the front panel for 5 seconds to change the setting back to its default.

##### HDMI Audio:

- This feature is available only when the display device is connected by an HDMI cable.

### 4 Auto Power Off: (Default: On)

Set to "On" to turn this unit off automatically after 30 minutes of no use.

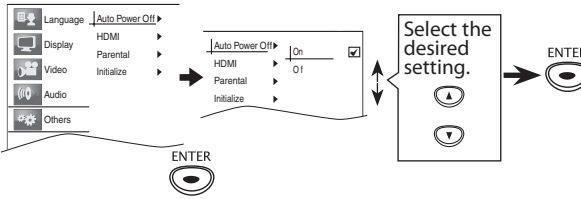

#### HDMI:

##### Resolution: (Default: Auto)

You can select the desired "Resolution" among the settings.

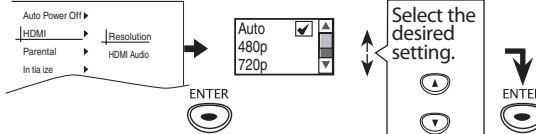

##### HDMI Audio: (Default: Bitstream)

Sets the audio format for the sound output from the HDMI OUT.

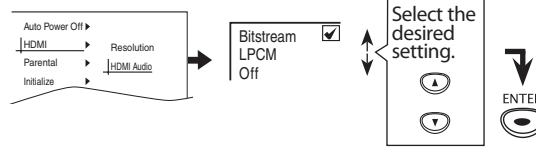

#### Parental:

Parental level allows you to set the rating levels of your DVD. Playback will stop if the ratings exceed the levels you set.

- \*1 If you have set a password already, "Enter your PIN" will be displayed and enter the current 4-digit password.
- \*2 If you have set a password already, enter your new PIN after entering the current password.

##### Rating Level: (Default: 8(Adult))

Sets the rating level for the disc playback.

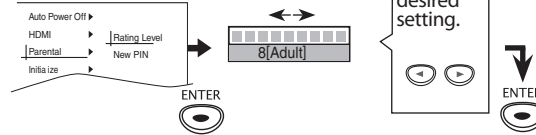

Enter your new 4-digit password (except for 4737).

\*1  
Enter New PIN  
-----

Enter your new 4-digit password again.

Confirm PIN  
-----

##### New PIN:

You can change your password for parental controls.

Enter your new 4-digit password.

\*1,2  
Enter New PIN  
-----

Enter your new 4-digit password again.

Confirm PIN  
-----

#### Initialize:

Reset to default setting.

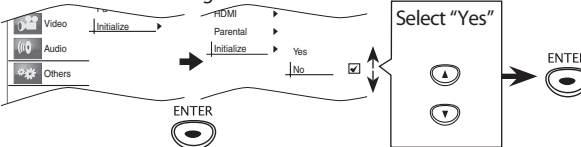

### 5 To exit "Auto Power Off", "HDMI" or "Parental" menu



#### Note:

##### Parental:

- If you forget the password, press [4], [7], [3], [7] at step 3 above, then enter your new password.

##### Initialize:

- When you do not wish to initialize, press [SETUP] to exit the menu at step 4.
- The setting for "Parental" will not be reset.

# INFORMATION

## Troubleshooting Guide

If the unit does not perform properly when operated as instructed in this owner's manual, refer to the following.

Problem	Corrective action
<b>No power.</b>	<ul style="list-style-type: none"> <li>-Check if the AC power cord is properly connected.</li> <li>-Unplug the outlet once, and wait for 5-10 seconds and then plug it in again.</li> </ul>
<b>No sound or picture.</b>	<ul style="list-style-type: none"> <li>-Check if the TV is switched on.</li> <li>-Check the video connection.</li> <li>-Check the audio/video cable connections to the TV. (Refer to page 6.)</li> <li>-When "Progressive" is "On", video signals from the unit's VIDEO OUT and S-VIDEO OUT jacks will be distorted or not be output at all.</li> <li>-Check whether the connected TV or other device supports HDCP. (This unit will not output a video signal unless the other device supports HDCP.)</li> </ul>
<b>Distorted picture.</b>	<ul style="list-style-type: none"> <li>-Sometimes a small amount of picture distortion may appear. This is not a malfunction.</li> <li>-Connect the unit directly to the TV.</li> <li>-Set "Progressive" correctly in "Video" menu. Turn it on only if your TV has progressive scan and you are using the component video connections between the unit and the TV. Disable progressive scan for all other connections. (Refer to page 6.)</li> </ul>
<b>Completely distorted picture or black/white picture with DVD.</b>	<ul style="list-style-type: none"> <li>-Connect this unit directly to the TV.</li> <li>-Make sure the disc is compatible with the unit.</li> </ul>
<b>No sound or distorted sound.</b>	<ul style="list-style-type: none"> <li>-Adjust the volume.</li> <li>-Check that the speakers are connected correctly.</li> </ul>
<b>No audio at digital output.</b>	<ul style="list-style-type: none"> <li>-Check the digital connections.</li> <li>-Check if the audio format of the selected audio language matches your receiver capabilities.</li> </ul>
<b>No DTS audio is output.</b>	<ul style="list-style-type: none"> <li>-This unit does not support DTS audio. This is not a malfunction.</li> </ul>
<b>Picture freezes momentarily during playback.</b>	<ul style="list-style-type: none"> <li>-Check the disc for fingerprints/dirty and clean with a soft cloth wiping from center to edge.</li> </ul>
<b>Disc cannot be played back.</b>	<ul style="list-style-type: none"> <li>-Clean the disc.</li> <li>-Ensure the disc is inserted in correct direction.</li> <li>-Check if the disc is defective by trying another disc.</li> <li>-Cancel the parental lock or change the control level.</li> <li>-Insert a correct disc that plays back on this unit.</li> <li>-Handle a disc with special care so that it does not have fingerprints, scratches, or dusts on its surface.</li> </ul>
<b>No return to start-up screen when disc is removed.</b>	<ul style="list-style-type: none"> <li>-Reset the unit by switching off the unit, then on again.</li> </ul>
<b>The unit does not respond to the remote control.</b>	<ul style="list-style-type: none"> <li>-Aim the remote control directly at the sensor on the front panel.</li> <li>-Reduce the distance to the unit.</li> <li>-Replace the batteries in the remote control.</li> <li>-Re-insert the batteries with their polarities (+/- signs) as indicated.</li> <li>-Tune your radio to an empty AM station so that you hear a lot of noises. Then, turn up the volume. If you hear some signal sound from the radio by pressing buttons on the remote control, the remote control is working.</li> <li>-Press and hold any button on remote control toward a digital camera. The remote control is working if you confirm infrared light through the digital camera.</li> </ul>
<b>Buttons do not work or the unit stops responding.</b>	<ul style="list-style-type: none"> <li>-To completely reset the unit, unplug the AC cord from the AC outlet for 5-10 seconds.</li> </ul>
<b>The unit does not respond to some operating commands during playback.</b>	<ul style="list-style-type: none"> <li>-Operations may not be permitted by the disc. Refer to the instructions of the disc.</li> </ul>
<b>The unit cannot read CD / DVD.</b>	<ul style="list-style-type: none"> <li>-Use a commonly available cleaning CD / DVD to clean the lens before sending the unit for repair.</li> </ul>
<b>Angle does not switch.</b>	<ul style="list-style-type: none"> <li>-The angle cannot be switched for DVD which do not contain multiple angles. In some cases multiple angles are only recorded for specific scenes.</li> </ul>
<b>Playback does not start when the title is selected.</b>	<ul style="list-style-type: none"> <li>-Check the "Parental" setting.</li> </ul>
<b>The password for rating level has been forgotten.</b>	<ul style="list-style-type: none"> <li>-Enter the default password "4737", then your forgotten password will be cleared.</li> </ul>

- Some functions are not available in specific modes, but this is not a malfunction. Read the description in this owner's manual for more details on correct operations.
- Playback from a desired track and random playback are not available during programmed playback.
- Some functions are prohibited on some discs.

## Specifications

Output signal format:  
NTSC color

Power source:  
120V AC +/- 10%, 60Hz +/- 0.5%

Power consumption:  
8W (standby : 0.8W)

Operating temperature:  
41°F (5°C) to 104°F (40°C)

Dimensions:  
W : 11.1 inches (280mm)  
H : 2.1 inches (51mm)  
D : 8.3 inches (210mm)

Weight:  
Approx 2.76lbs.(1.25kg)

• Designs and specifications are subject to change without notice.

• If there is a discrepancy between languages, the default language will be English.

## 1 Conexiones

Si su televisor tiene entradas de AUDIO/VIDEO vea la sección "Connection to a TV" en la página 6 en el manual de manejo. En caso contrario, vea la sección "Connecting to RF Modulator (Not Supplied)" en la página del frente en el manual de manejo.

## 2 Instalación de las pilas en el control remoto



## 3 Para cambiar el idioma en la pantalla

**1 Confirme que ha seleccionado "Language".**



**2 Seleccione "Player Menu".**



**3 Seleccione el idioma deseado para las indicaciones en la pantalla.**



**4 Para salir del menú**

## 4 Reproducción

Antes. Encienda el televisor, amplificador y otros equipos conectados a esta unidad. Asegúrese que el televisor y el sintonizador de audio (no provisto) están en el canal correcto.

**1** Para abrir o cerrar la bandeja del disco

STANDBY ON → OPEN/CLOSE

**2** Ponga un disco con la etiqueta hacia arriba.

**3** Para empezar la reproducción

PLAY

**4** Para parar la reproducción

STOP

## 5 Control remoto

Botón (orden alfabético)	Disco	DVD	CD MP3 JPEG
0-9	• Para especificar valores en el campo de entrada. • Para seleccionar directamente el capítulo o título.		• Para especificar valores en el campo de entrada. • Para seleccionar directamente la canción. (CD) • Para seleccionar la carpeta / archivo directamente. (MP3 / JPEG)
← →	• Para mover el cursor y determinar la posición.		• Para mover el cursor y determinar la posición. • Para girar la imagen JPEG.
A-B	• Para repetir entre su punto A y B seleccionado.		• Para repetir entre su punto A y B seleccionado. (CD / MP3)
ANGLE	• Para seleccionar los ángulos de la cámara en un disco.		—
AUDIO	• Para seleccionar idiomas de audio en un disco.		• Para seleccionar "Estéreo", "L-ch" o "R-ch". (CD)
CLEAR	• Para borrar el punto para la repetición A-B. • Para borrar los números mal entrados.		• Para borrar el punto para la repetición A-B. (CD / MP3) • Para eliminar el N° de estado en la entrada de programa. • Para borrar los números mal entrados.
DISPLAY	• Para mostrar el modo de disco actual.		• Para mostrar el modo de disco actual.
ENTER	• Para seleccionar opciones o valores de configuración.		• Para seleccionar opciones o valores de configuración.
HDMI	• Para establecer el modo de salida HDMI.		• Para establecer el modo de salida HDMI.
REV FWD	• Para buscar en avance/retroceso por un disco. (x2, x4, x8, x16, x32) • Para empezar la reproducción en avance lento durante el modo de pausa.		• Para buscar en avance/retroceso por un disco. (x2, x4, x8, x16, x32)
MENU	• Para llamar el menú en un disco.		—
MODE			• Para disponer el orden de reproducción o la reproducción aleatoria.
OPEN/CLOSE	• Para abrir o cerrar la bandeja del disco. • Para encender la unidad.		• Para abrir o cerrar la bandeja del disco. • Para encender la unidad.
PAUSE	• Para hacer una pausa en la reproducción. • Para avanzar la reproducción un cuadro cada vez.		• Para hacer una pausa en la reproducción del disco.
PLAY	• Para iniciar o reanudar la reproducción.		• Para iniciar o reanudar la reproducción.
REPEAT	• Para reproducir repetidamente un capítulo o título.		• Para reproducir repetidamente una canción o disco. (CD) • Para reproducir un archivo, carpeta o disco reiteradamente. (MP3 / JPEG)
RETURN	• Para volver al menú o pantalla anteriormente visualizado.		• Para volver al menú o pantalla anteriormente visualizado. • Cuando aparezca la lista de archivos, presiónelo para cambiar a la lista de carpetas. (MP3 / JPEG)
SEARCH MODE	• Para buscar un capítulo, título o tiempo.		• Para buscar pistas o archivos. • Para buscar el tiempo. (CD / MP3) • Para buscar los grupos. (MP3 / JPEG)
SETUP	• Para llamar el menú de ajustes de DVD.		• Para llamar el menú de ajustes de DVD.
SKIP	• Para saltar capítulos o título.		• Para saltar pistas o archivos. • Cuando aparezca la lista de archivos / carpetas, presiónelo para cambiar de una página a otra. (MP3 / JPEG)
STANDBY-ON	• Para encender o para pasar la unidad al modo de espera. (Para apagar completamente la unidad, debe desconectar el cable de alimentación de CA.)		• Para encender o para pasar la unidad al modo de espera. (Para apagar completamente la unidad, debe desconectar el cable de alimentación de CA.)
STOP	• Para parar la reproducción.		• Para parar la reproducción.
SUBTITLE	• Para seleccionar el idioma de subtítulos de un disco.		—
TOP MENU	• Para visualizar el menú de títulos de un disco.		—
ZOOM	• Para ampliar la imagen de vídeo en DVD. (x2, x3, x4, x1/2, x1/3, x1/4)		• Para ampliar la imagen de vídeo en DVD. (JPEG) (x2, x3, x4, x1/2, x1/3, x1/4)

# MAGNAVOX LIMITED WARRANTY

FUNAI CORP. will repair this product, free of charge in the USA in the event of defect in materials or workmanship as follows:

**DURATION:**

**PARTS:** FUNAI CORP. will provide parts to replace defective parts without charge for one (1) year from the date of original retail purchase. Certain parts are excluded from this warranty.

**LABOR:** FUNAI CORP. will provide the labor without charge for a period of ninety (90) days from the date of original retail purchase.

**Note: Any product sold and identified as refurbished or renewed carries a ninety (90) days labor and parts limited warranty.**

**LIMITS AND EXCLUSIONS:**

This warranty is extended only to the original retail purchaser. A purchase receipt or other proof of original retail purchase will be required together with the product to obtain service under this warranty.

This warranty shall not be extended to any other person or transferee.

This warranty is void and of no effect if any serial numbers on the product are altered, replaced, defaced, missing or if service was attempted by an unauthorized service center. This limited warranty does not apply to any product not purchased and used in the United States.

This product is produced for home use and this warranty only covers failures due to defects in material or workmanship which occurs during normal use. It does not cover damage which occurs in shipment, or failures which are caused by repairs, alterations or product not supplied by FUNAI CORP., or damage which results from accident, misuse, abuse, mishandling, misapplication, alteration, faulty installation, improper maintenance, commercial use such as hotel, rental or office use of this product or damage which results from fire, flood, lightning or other acts of God.

THIS WARRANTY DOES NOT COVER PACKING MATERIALS, ANY ACCESSORIES (EXCEPT REMOTE CONTROL), ANY COSMETIC PARTS, COMPLETE ASSEMBLY PARTS, DEMO OR FLOOR MODELS. FUNAI CORP. AND ITS REPRESENTATIVES OR

AGENTS SHALL IN NO EVENT BE LIABLE FOR ANY GENERAL, INDIRECT OR CONSEQUENTIAL DAMAGES ARISING OUT OF OR OCCASIONED BY THE USE OF OR THE INABILITY TO USE THIS PRODUCT. THIS WARRANTY IS MADE IN LIEU OF ALL OTHER WARRANTIES, EXPRESS OR IMPLIED, AND OF ALL OTHER LIABILITIES ON THE PART OF FUNAI, ALL OTHER WARRANTIES INCLUDING THE WARRANTY OF MERCHANTABILITY, AND FITNESS FOR A PARTICULAR PURPOSE, ARE HEREBY DISCLAIMED BY FUNAI AND ITS REPRESENTATIVES IN THE UNITED STATES. ALL WARRANTY INSPECTIONS AND REPAIRS MUST BE PERFORMED BY AN AUTHORIZED SERVICE CENTER. THIS WARRANTY IS VALID WHEN THE UNIT IS CARRIED-IN TO AN AUTHORIZED SERVICE CENTER.

**IMPORTANT:**

THIS LIMITED WARRANTY GIVES YOU SPECIFIC LEGAL RIGHTS. YOU MAY HAVE OTHER RIGHTS THAT VARY FROM STATE TO STATE. IF, AT ANY TIME DURING THE WARRANTY PERIOD, YOU ARE UNABLE TO OBTAIN SATISFACTION WITH THE REPAIR OF THIS PRODUCT, PLEASE CONTACT FUNAI CORP.

**ATTENTION:**

FUNAI CORP. RESERVES THE RIGHT TO MODIFY ANY DESIGN OF THIS PRODUCT WITHOUT PRIOR NOTICE.

**WARRANTY STATEMENT REGARDING NON AUTHORIZED REPAIRS:**

To obtain warranty service, you must take the product, or deliver the product freight prepaid, in either its original packaging or packaging affording an equal degree of protection, to any AUTHORIZED SERVICE CENTER. FUNAI CORP. will not reimburse you for any service done by unauthorized service providers without prior written approval.

**To locate your nearest AUTHORIZED SERVICE CENTER or for general service inquiries, please contact us at:**

**FUNAI SERVICE CORPORATION**

**Tel :1-800-605-8610**

**[www.magnavox.com/support](http://www.magnavox.com/support)**

2200 Spiegel Drive, Groveport, OH 43125